

RSIC-1 EXT04 SOUND ISOLATION CLIP

RSIC-1 EXT04 INSTALLATION GUIDE

RSIC-1 EXT04



PAC International, LLC. Tel: (866) 774-2100 Web Site: www.pac-intl.com

© PAC International, LLC. All Rights Reserved. • (866) 774-2100 • Fax (866) 649-2710
RSIC® is a registered Trade Mark.

RSIC-1 EXT04 SOUND ISOLATION CLIP

RSIC-1 EXT04 INSTALLATION GUIDE

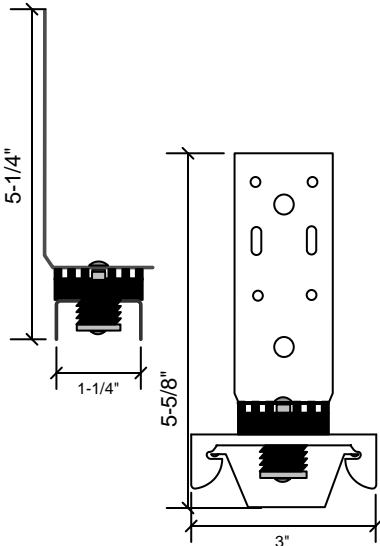
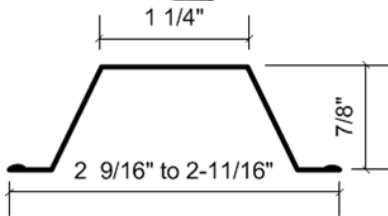

Furring Channel:

Minimum requirements: 25 gauge, hemmed edge detail required on all 25 gauge furring channel. Meets or exceeds SSMA min. requirements.

Optional: 22 Gauge (no hemmed edge required with 22 gauge)

Depth: 7/8 inch

Width Bottom: 2-9/16" to 2-11/16" inch wide nominal.

Width Top: 1-1/4 inch wide

Splice drywall furring channel (hat track) with 6 inch overlap in mid span (between two clip) secure with 18 Ga tie wire, or two 7/16" framing screws.

Resilient Sound Isolation Clip (RSIC-1 EXT04)

Spacing: maximum 48 inches on center

Maximum acoustical design load: 36 lbs

Fasteners:

RSIC-1 EXT04 to wood: #8 x 1-1/2 inch minimum size coarse thread screw.

RSIC-1 EXT04 to Steel: # 8 x 9/16" minimum size fine thread screw.

DO NOT fasten Resilient Sound Isolation Clips (RSIC-1) to framing members with nails. Use only approved screws.

RSIC-1 EXT04 dimensions:

RSIC-1 EXT04 clip 3" wide

RSIC-1 EXT04 and Drywall Furring Channel 5-5/8" deep

RSIC-1 EXT04 clip 1-1/4" deep

Labor rates provided to PAC International, Inc by independent contracting firm

Average Labor Rates:

RSIC-1 EXT04: 60 clips per man hour

Drywall Furring Channel: 550LF per man hour

Labor rates provided to PAC International, Inc by independent contracting firm

PAC International, LLC. Tel: (866) 774-2100 Web Site: www.pac-intl.com

© PAC International, LLC. All Rights Reserved. • (866) 774-2100 • Fax (866) 649-2710
RSIC® is a registered Trade Mark.

RSIC-1 EXT04 SOUND ISOLATION CLIP

RSIC-1 EXT04 INSTALLATION GUIDE

Ceilings: One and Two layer 5/8" gypsum

- Resilient Sound Isolation Clip (RSIC-1 EXT04) shall be 48 inches (1219mm) on center maximum. (Perpendicular to Joist/Truss)
-
- Fasten the Resilient Sound Isolation Clip (RSIC-1 EXT04) to the side of the structural members with approved fasteners
-
- Ensure the metal "L" bracket is tight to the framing member.
-
- Locate the first row RSIC-1 EXT04 clips is within 8 inches of the wall at each end of a run.
-
- Snap in the drywall furring channel (hat track) into the RSIC-1 clip at right angles (perpendicular or parallel) to the framing members.

General Information:

- Resilient Sound Isolation Clip (RSIC-1 EXT04), Furring Channel (hat track) and Gypsum board shall not carry heavy loads such as cabinets or bookshelves
-
- Splice furring channel (hat track) with 6 inch overlap in mid span, secure with 18 Ga. Tie wire or with two framing screws (7/16")
-
- Seal all potential air leaks with non-hardening acoustical caulking to achieve best noise control results. Use fire rated sealant where required.

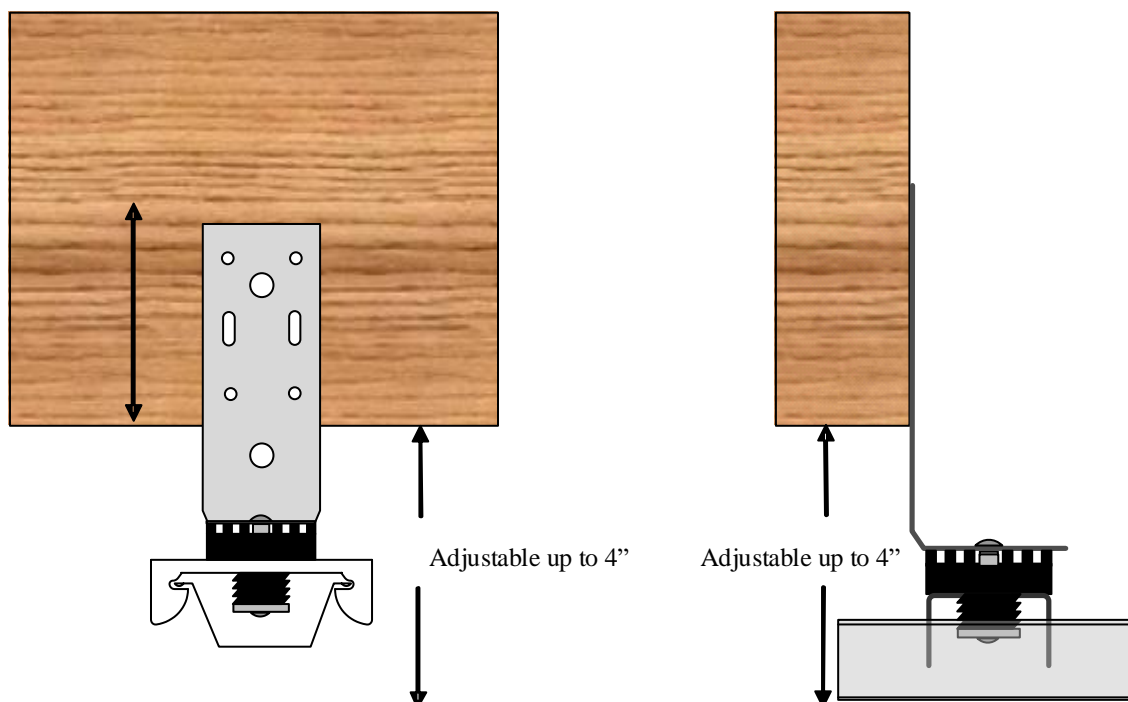

PAC International, LLC. Tel: (866) 774-2100 Web Site: www.pac-intl.com

© PAC International, LLC. All Rights Reserved. • (866) 774-2100 • Fax (866) 649-2710
RSIC® is a registered Trade Mark.

RSIC-1 EXT04 SOUND ISOLATION CLIP

RSIC-1 EXT04 INSTALLATION GUIDE

RSIC-1 EXT04 Ceiling System Framing at 24" o.c.

RSIC-1 EXT04 clips at 24" x 48" O.C. Up to 2 layers of 5/8" gypsum board

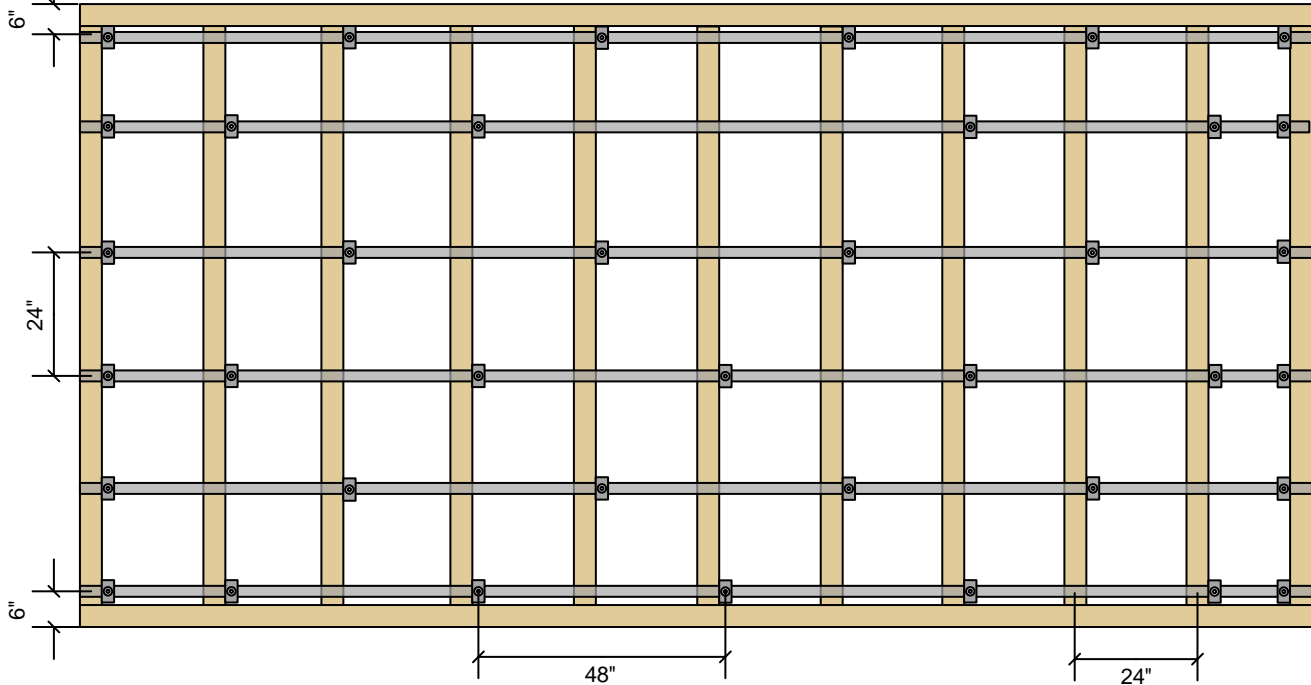

RSIC-1 EXT04 Ceiling System Framing at 16" o.c.

RSIC-1 EXT04 clips at 24" x 48" O.C. Up to 2 layers of 5/8" gypsum board

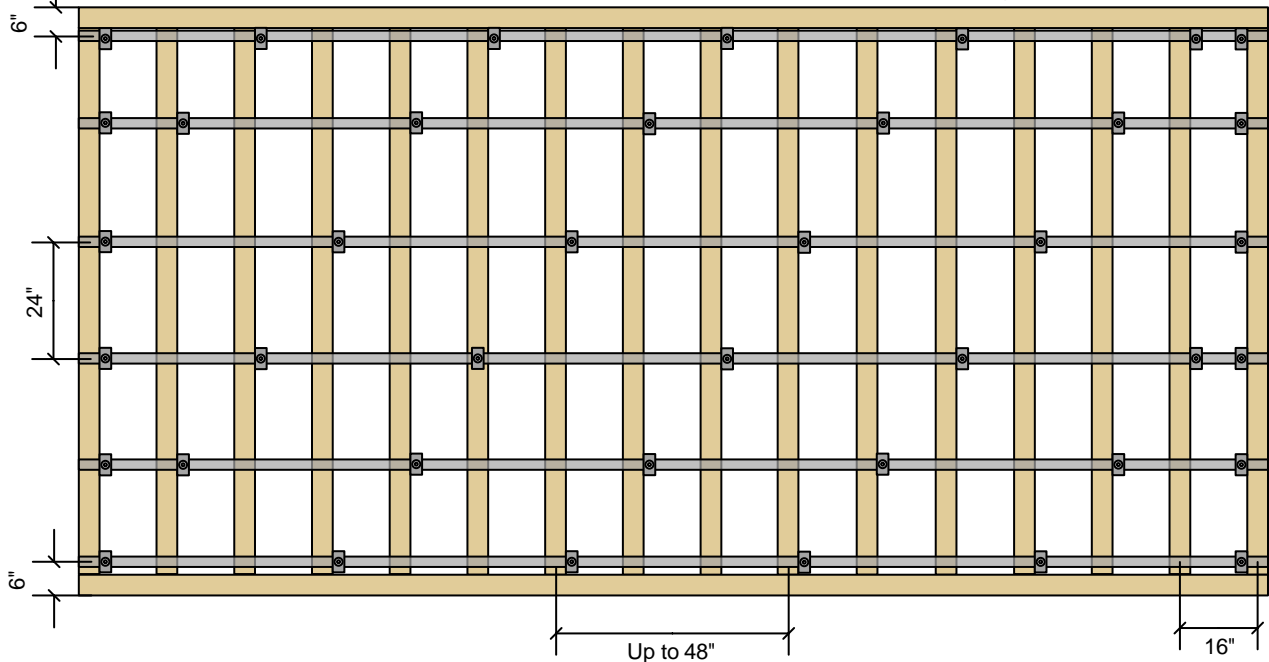

PAC International, LLC. Tel: (866) 774-2100 Web Site: www.pac-intl.com

© PAC International, LLC. All Rights Reserved. • (866) 774-2100 • Fax (866) 649-2710
RSIC® is a registered Trade Mark.

RSIC-1 EXT04 SOUND ISOLATION CLIP

RSIC-1 EXT04 INSTALLATION GUIDE

RSIC-1 EXT04 Ceiling System Framing at 24" o.c.

RSIC-1 EXT04 clips at 16" x 48" O.C. Up to 3 layers of 5/8" gypsum board

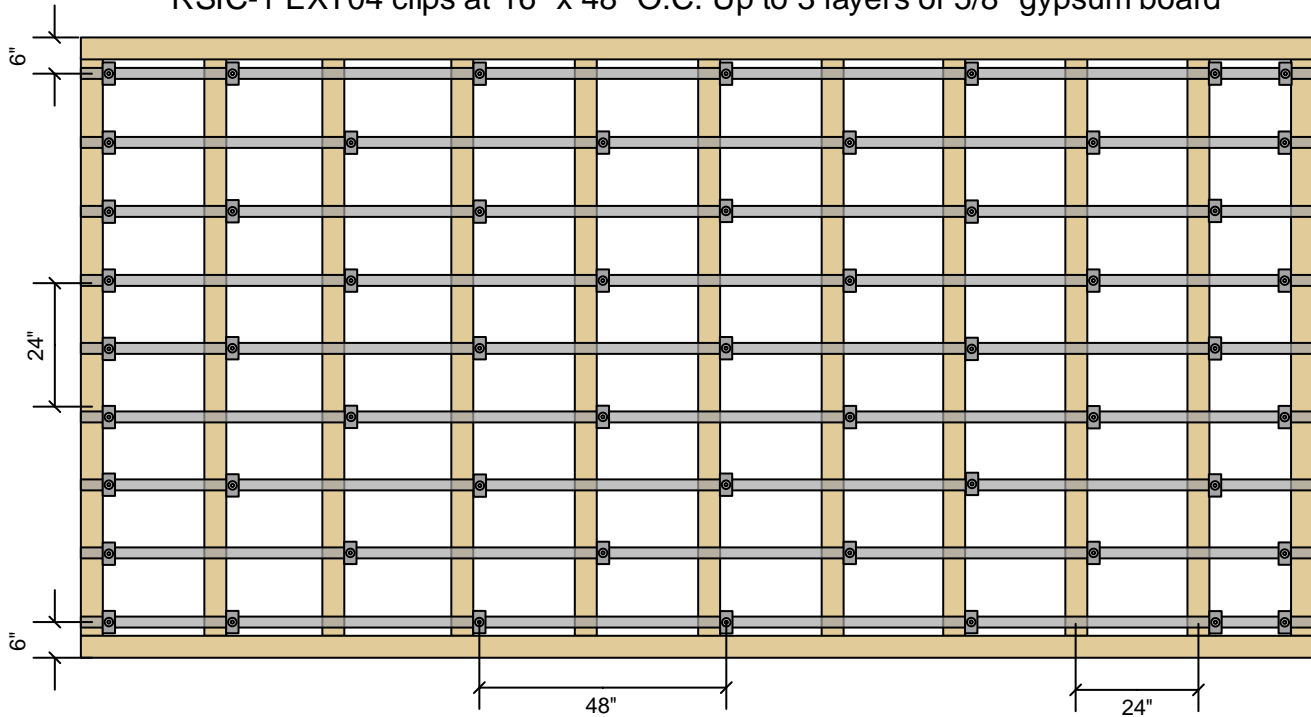

RSIC-1 EXT04 Ceiling System Framing at 16" o.c.

RSIC-1 EXT04 clips at 16" x 48" O.C. Up to 3 layers of 5/8" gypsum board

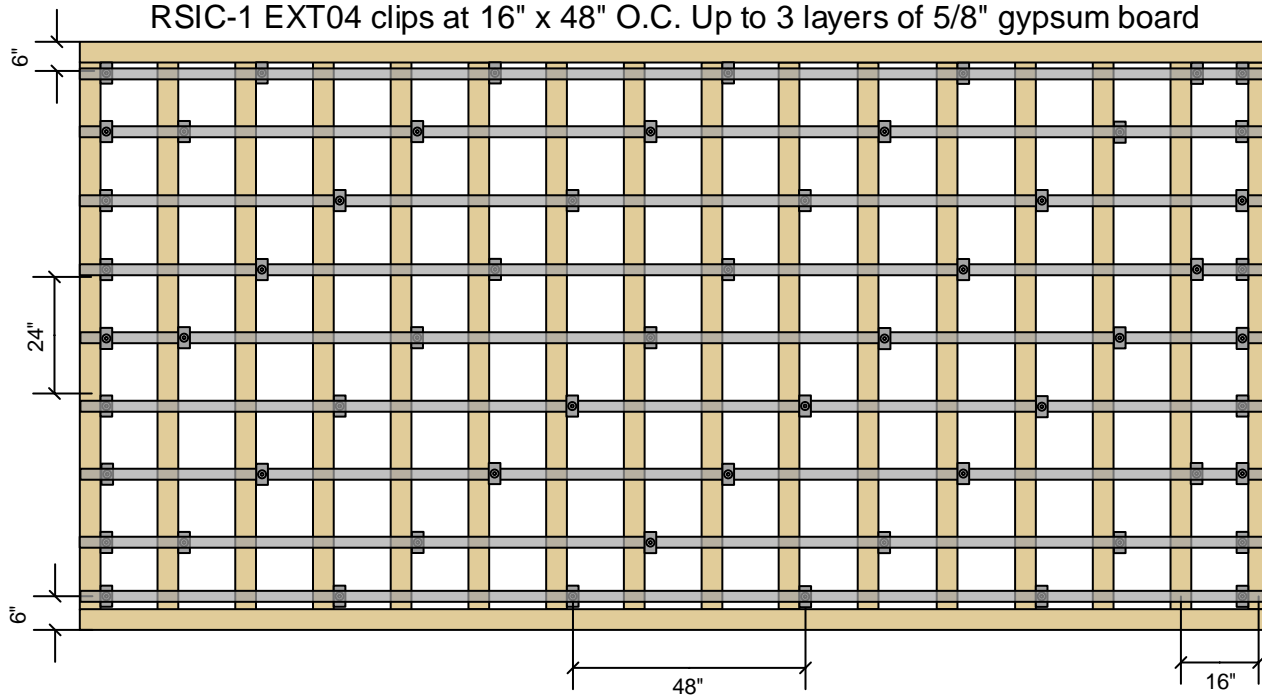

PAC International, LLC. Tel: (866) 774-2100 Web Site: www.pac-intl.com

© PAC International, LLC. All Rights Reserved. • (866) 774-2100 • Fax (866) 649-2710
RSIC® is a registered Trade Mark.

RSIC-1 EXT04 SOUND ISOLATION CLIP

RSIC-1 EXT04 INSTALLATION GUIDE



Members of the International
Code Council

WARRANTY DISCLAIMER AND LIABILITY LIMITATION LANGUAGE

NO EXPRESS OR IMPLIED WARRANTIES

THERE IS NO WARRANTY, REPRESENTATION OR CONDITION OF ANY KIND; AND ANY WARRANTY, EXPRESS OR IMPLIED, IS EXCLUDED AND DISCLAIMED, INCLUDING THE IMPLIED WARRANTIES OF MERCHANTABILITY AND OF FITNESS FOR A PARTICULAR PURPOSE. Some states do not allow limitations on implied warranties, so the above limitation may not apply to you.

LIABILITY LIMITED TO RETURN OF PURCHASE PRICE

IT IS AGREED THAT SELLER'S LIABILITY AND PURCHASER'S SOLE REMEDY, WHETHER IN CONTRACT, UNDER ANY WARRANTY, IN TORT (INCLUDING NEGLIGENCE), IN STRICT LIABILITY OR OTHERWISE, SHALL NOT EXCEED THE RETURN OF THE AMOUNT OF THE PURCHASE PRICE PAID BY PURCHASER, AND UNDER NO CIRCUMSTANCES SHALL SELLER BE LIABLE FOR ANY SPECIAL, INCIDENTAL OR CONSEQUENTIAL DAMAGES, INCLUDING, BUT NOT LIMITED TO, PERSONAL INJURY, PROPERTY DAMAGE, DAMAGE TO OR LOSS OF EQUIPMENT, LOST PROFITS OR REVENUE, COSTS OF RENTING REPLACEMENTS AND OTHER ADDITIONAL EXPENSES, EVEN IF SELLER HAS BEEN ADVISED OF THE POSSIBILITY OF SUCH DAMAGES. THE PRICE STATED FOR THE EQUIPMENT IS A CONSIDERATION IN LIMITING SELLER'S LIABILITY AND PURCHASER'S REMEDY. Some states do not allow the exclusion or limitation of incidental or consequential damages, so the above limitation or exclusion may not apply to you.

SELLER NOT LIABLE FOR PURCHASER'S NEGLIGENCE

SELLER WILL NOT BE LIABLE FOR ANY DAMAGES, LOSSES OR EXPENSES AS A RESULT OF PURCHASER'S NEGLIGENCE, WHETHER DEEMED ACTIVE OR PASSIVE AND WHETHER OR NOT ANY SUCH NEGLIGENCE IS THE SOLE CAUSE OF ANY SUCH DAMAGE, LOSS OR EXPENSE.

MODEL FOR DEMONSTRATION PURPOSES ONLY

THE MODEL OR SAMPLE SHOWN BY SELLER TO BUYER IS USED FOR DEMONSTRATION PURPOSES ONLY. THERE IS NO WARRANTY THAT THE GOODS AS DELIVERED SHALL CONFORM TO THE MODEL OR SAMPLE, AND CONFORMITY OF THE GOODS TO THE MODEL OR SAMPLE IS NOT PART OF THE BASIS OF THE BARGAIN BETWEEN SELLER AND BUYER.

NO WARRANTY OR COMPLIANCE WITH SAFETY CODE OR REGULATION

SELLER DOES NOT WARRANT THAT ANY OF THE GOODS SOLD WILL MEET OR COMPLY WITH THE REQUIREMENTS OF ANY SAFETY CODE, BUILDING OR DWELLING CODE, OR REGULATION OF ANY STATE, MUNICIPALITY OR OTHER JURISDICTION.

NEVADA LAW APPLIES

SELLER AND BUYER AGREE THAT ALL ASPECTS OF THIS TRANSACTION INCLUDING THE APPLICABLE STATUTE OF LIMITATIONS SHALL BE GOVERNED BY THE INTERNAL LAW OF THE STATE OF NEVADA, AND NOT THE LAWS OF CONFLICTS.

This warranty gives you specific legal rights, and you may also have other rights which vary from state to state

PAC International, LLC. Tel: (866) 774-2100 Web Site: www.pac-intl.com

© PAC International, LLC. All Rights Reserved. • (866) 774-2100 • Fax (866) 649-2710
RSIC® is a registered Trade Mark.